

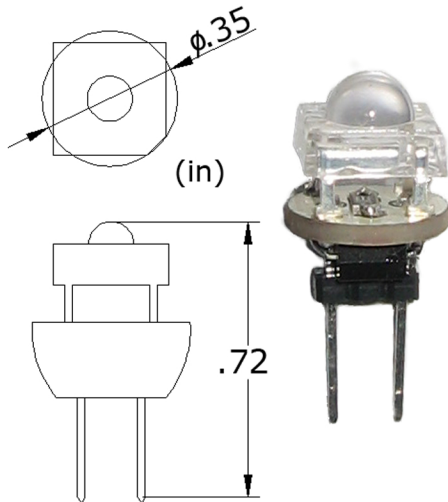











LEDLight.com

G4 Super Flux 1 LED 12 Volt AC/DC



10 Lumen output. 1W Halogen equivalent. 0.2 Watt power consumption. 30 mA current consumption. Available in white 6500 Kelvin or warm white 3000 Kelvin. 50,000 hour life. 60 Degree viewing angle. GX4.0 base. Operating voltage 12V AC or 12V DC. 0.35 inch diameter x 0.70 inch height. No ultraviolet (UVA, UVB) or radiofrequency (RF) energy. Can be dimmed with a variable AC or DC voltage supply. One per package.

| | |
|-------------------------|--------------------|
| Part# | 72253 |
| Part Description | One flux LED |
| Lamp Type | LED |
| Lamp Base | GX4.0 |
| Unit Wattage | 0.2W |
| Voltage | 12V AC/DC |
| Frequency | 50-60Hz |
| Operating Temperature | -40~60° |
| Environment Temperature | 30° |
| Operating Humidity | Ta=60° RH=90% |
| IP Class | 0 |
| Ventilation | |
| Weight | 1g |
| Size | 9x H18mm |
| Package Type | white box |
| Number/ Carton | 400pcs |
| Carton Size | 17x11x8cm |
| Certificates | CE, RoHS |
| Lense Type | |
| Body Type | Flux LED |
| Work Environment | |
| Luminous Efficacy | 40lm |
| Lumen Maintenance | 90% after 1,000hrs |
| LED Life | 50,000hrs |
| Warranty | 1 year |

| Color | Beam Angle | Forward Lumen | Side Lumen | # of LEDs | # of chips per LED | LED Type | Kelvin | Wave Length | Amps | LED Watts | Unit Watts | CRI |
|---|------------|---------------|------------|-----------|--------------------|-----------|--------|-------------|------|-----------|------------|-----|
| W  | 60° | 10lm | | 1pcs | 1pcs | superflux | 6500K | | | 0.2W | 0.12 | 75 |
| DW  | | | | | | | | | | | | |
| WW  | | | | | | | | | | | | |
| R  | | | | | | | | | | | | |
| G  | | | | | | | | | | | | |
| B  | | | | | | | | | | | | |
| Y  | | | | | | | | | | | | |
| UV  | | | | | | | | | | | | |
| RGB  | | | | | | | | | | | | |

LEDLight.com LLC

12215 East Chandler Heights Rd Chandler, AZ 85249

Toll Free 1(877)283-5060 Local 1(602)997-0366 Fax 1(602)861-4088