

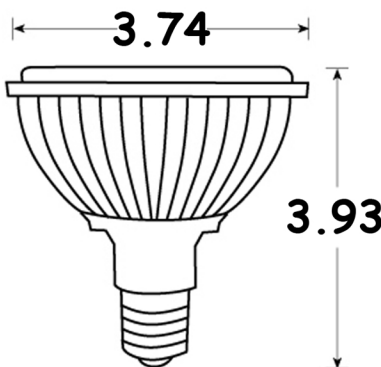

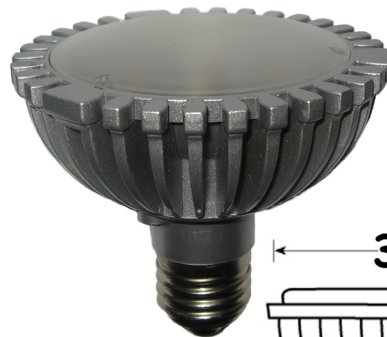









LEDLight.com

PAR30 Seven 1 Watt Wide Angle LED Light



Light output 420 Lumens, 50W incandescent equivalent. 7.0 Watt power consumption. 6000-7000 Kelvin white or 2800-3300 Kelvin warm white. 45 Degree viewing angle. Wide voltage 85 VAC - 265 VAC. Reflector efficiency of 90%. CE Approved. 3.74 inch diameter x 3.93 inch Height. The body is aluminum which helps the seven 1 Watt LED Lights stay cool, which helps the LED last longer.

Part#	86754
Part Description	PAR30 Seven 1 Watt Wide Angle
Lamp Type	High Power LED Light
Lamp Base	E27
Unit Wattage	8.3W
Voltage	100-240V
Frequency	50-60Hz
Operating Temperature	<60°C
Environment Temperature	<25°C
Operating Humidity	0-95% non-condensity humidity
IP Class	IP5/4
Ventilation	Good Ventilation
Weight	300g
Size	95x80mm
Package Type	gift-box
Number/ Carton	48PCS
Carton Size	43x43x33
Certificates	CE, RoHS
Lense Type	Plastic
Body Type	Aluminum
Work Environment	Indoor
Luminous Efficacy	
Lumen Maintenance	
LED Life	50,000hrs
Warranty	1 Year

Color	Beam Angle	Forward Lumen	Side Lumen	# of LEDs	# of chips per LED	LED Type	Kelvin	Wave Length	Amps	LED Watts	Unit Watts	CRI
W 	15/30/45 /60	7x60		7		Seoul/ Edison	6000-7000k		300mA	7	8.3	80%
DW 	15/30/45 /60	7x55		7		Seoul/ Edison	3500-4500k		300mA	7	8.3	80%
WW 	15/30/45 /60	7x45		7		Seoul/ Edison	2800-3300k		300mA	7	8.3	80%
R 												
G 												
B 												
Y 												
UV 												
RGB 												

LEDLight.com LLC

12215 East Chandler Heights Rd Chandler, AZ 85249

Toll Free 1(877)283-5060 Local 1(602)997-0366 Fax 1(602)861-4088